



**MOISTURE METERS**  
dewpoint meters & hygrometers

# Superdew 3

## Hygrometer



# Operating Instructions



JLC International  
Phone: 215-340-2650  
Fax: 215-340-3670

948 Lenape Drive Town Center, New Britain, PA 18901  
[jlcusa@jlcinternational.com](mailto:jlcusa@jlcinternational.com)  
[www.jlcinternational.com](http://www.jlcinternational.com)



**Shaw Moisture Meters (UK) Ltd**

Len Shaw Building  
Bolton Lane  
Bradford  
BD2 1AF  
England

t. +44 (0) 1274 733582  
f. +44 (0) 1274 370151  
e. [mail@shawmeters.com](mailto:mail@shawmeters.com)

[www.shawmeters.com](http://www.shawmeters.com)

# Unpacking your Shaw Moisture Meters Superdew 3

Please examine the Superdew 3 package for any damage or mishandling. If any damage is evident please notify the carrier and the Shaw Moisture Meters representative from where this unit was purchased.

You should have received (if ordered):

- 1 Superdew 3 Instrument
- 1 Shaw Sensor
- 1 Connecting cable (of the length specified on your order) or 2m as standard.
- 1 Sensor holder
- 1 Instruction Manual
- 1 Pressure Dewpoint Circular Calculator





**If anything is missing please contact your distributor immediately.**



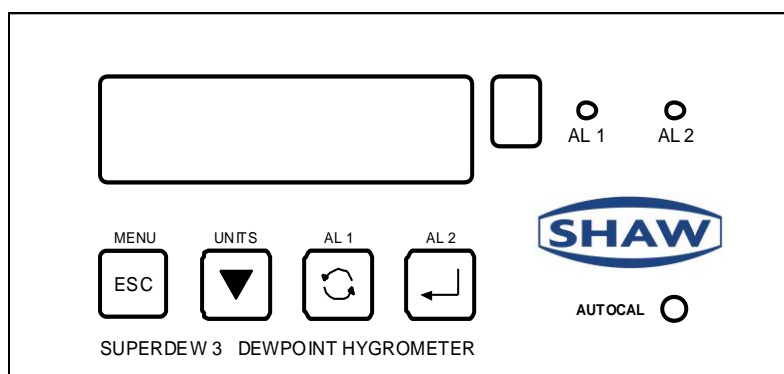

# Index

<b>1</b>	<b>General Information .....</b>	<b>1</b>
<b>2</b>	<b>Safety Information .....</b>	<b>2</b>
2.1	Warning .....	2
2.2	Isolation .....	2
<b>3</b>	<b>Installation .....</b>	<b>2</b>
3.1	Installing the instrument into a panel .....	2
3.2	Instrument wiring .....	3
3.3	Power supply .....	3
3.4	Alarm and output cable connectors .....	3
3.5	Sensor cable .....	3
<b>4</b>	<b>Installing the air/gas sampling system .....</b>	<b>4</b>
4.1	Piping installation schematic .....	5
4.2	Piping schematic component index .....	5/6
<b>5</b>	<b>Installing and commissioning the sensor .....</b>	<b>6</b>
<b>6</b>	<b>Default instrument configuration .....</b>	<b>7</b>
<b>7</b>	<b>Programming the Superdew 3 .....</b>	<b>7</b>
7.1	Principle of entering numerical data .....	7
<b>8</b>	<b>Configuring the Superdew 3 .....</b>	<b>7/8</b>
8.1	rAngE .....	8
8.2	oUtPt .....	8
8.3	AL1 & AL2 .....	8/9
8.4	rS485 (communications) .....	9
8.5	PASS .....	9
8.6	PAnEL .....	9
<b>9</b>	<b>Normal operation of the Superdew 3 .....</b>	<b>10</b>
<b>10</b>	<b>Hotkeys .....</b>	<b>10</b>
10.1	Alarm Hotkeys .....	10
10.2	Units .....	10
<b>11</b>	<b>Calibration (Sensor Ranges up to 0°C Dewpoint) .....</b>	<b>11</b>
<b>12</b>	<b>Calibration (Sensor Ranges up to +20°C Dewpoint) .....</b>	<b>11</b>
<b>13</b>	<b>Monitoring the System .....</b>	<b>11/12</b>
<b>14</b>	<b>Faults / Errors .....</b>	<b>12</b>
<b>15</b>	<b>Superdew 3 Specification .....</b>	<b>12</b>
<b>16</b>	<b>Appendix A – Superdew 3 Setup Menu Flow Diagram</b>	
<b>17</b>	<b>Appendix B – Alarm 1 &amp; 2 Hotkey Flow Diagram</b>	
<b>18</b>	<b>Appendix C – Units Hotkey Flow Diagram</b>	

## General Information



Every key on the Superdew 3 has two functions, the control function ( , ,  &  ) and the Hotkey function (Menu, Units, Alarm 1 and Alarm 2). The use of these commands is described in the table below:

<b>Key</b>	<b>Control function</b>	<b>Hotkey function</b>
The  (Menu) key	Returns the user to the previous screen, often without changing any variables.	Used to enter the setup menu by pressing and holding for more than 5 seconds
The  (Units) key	Used to decrease the selected digit when setting a numerical variable.	Used to enter the Units menu
The  (AL 1) key	Used to select the next digit when setting a numerical variable or to scroll through the options available.	Used to enter the Alarm 1 menu
The  (AL 2) key	Used to confirm a numerical variable or the selection of a chosen option.	Used to enter the Alarm 2 menu

- The Superdew 3 is a DIN style panel mounted moisture monitoring device designed to work in conjunction with the Shaw Sensors.
- The readout of moisture content is displayed on a backlit, 5-digit, seven segment LED, and available in any one of **four** selectable engineering units. The selected unit is indicated on a separate seven segment LED.
- The instrument is available in an AC or DC version.
- The Superdew 3 operation is controlled by a four-button membrane keypad. The user-friendly software uses a simple menu selection process and incorporates three hot keys to enable moisture levels to be read in different units, and this allows quick access to both alarm settings.
- A user controllable security system.
- The Superdew 3 has an autocal potentiometer to perform auto-calibration of sensors.
- The Superdew 3 has two full range alarms that can be set as rising or falling edge triggered. These alarms have visual indication (LEDs) and activate changeover relays for remote indication or control.
- The Superdew 3 has a fully controllable linear 4-20mA output.
- The Superdew 3 also has RS485 capabilities, outputs the process variable and unit status when polled.
- Details of normal operation, engineering unit selection, and configuration of the instrument are described within this manual.

## Safety Information

Read the safety information below, **before installation**.

### 2.1 Warning

Hazardous voltages may be present on instrument terminals. The equipment must be installed by suitably qualified personnel and the instrument must be mounted in a position that provides protection behind the panel to at least IP20.

### 2.2 Isolation

The power supply terminals and associated internal circuitry are isolated from all other parts of the equipment in accordance with EN61010-1 for connection to a category II supply (pollution degree 2). Any terminals or wiring connected to the input or output, which are accessible in normal operation, must only be connected to signals complying with the requirements for Safety Extra Low Voltage (SELV) circuits.

The mains supply to the instrument must be protected by an external 1-amp fuse and a suitable switch or circuit breaker, which should be near the instrument.

**Note:** *The instrument contains no user serviceable parts.*

## Installation

### 3.1 Installing the instrument into a panel

Make a cut-out in the donor panel 138.0 x 68.0mm (DIN 43700).

The maximum panel thickness is 8mm. If an effective IP65 weatherproof seal is required, the minimum recommended panel thickness is 2.5mm.

Pass the instrument case through the cut-out in the donor panel and attach the two retaining screws to the studs on either side of the case.

Tighten the retaining screws onto the back of the donor panel until the instrument is clamped securely in position. The screws must be tightened sufficiently to affect a seal between the front of the donor panel and the back of the instrument bezel, but never over tightened.

### 3.2 Instrument wiring

Wire the Superdew 3 as per figure 1.1 below.

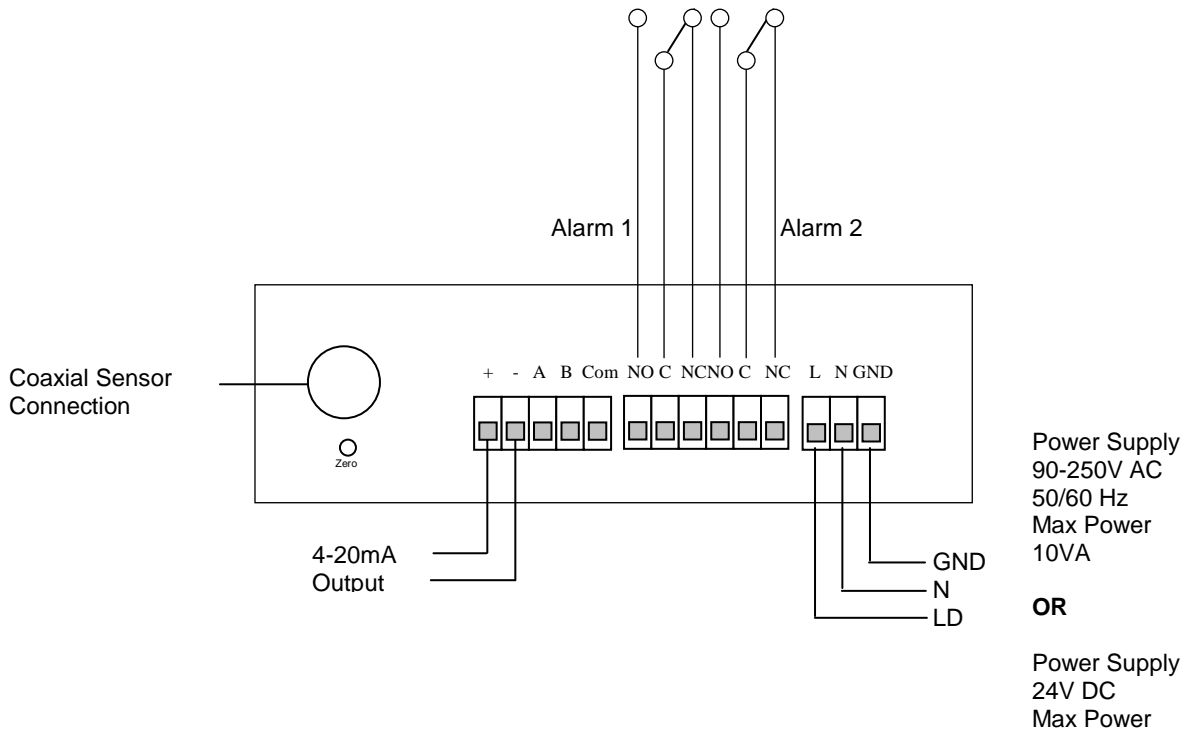

### 3.3 Power supply

The Superdew 3 can be powered by either a 90-250V AC or 24V DC supply. Connect the required supply cable to the appropriate terminals as shown in figure 1.1.

The AC power supply should be between 90 - 250V AC @ 50/60Hz.

The power supply wires are retained by screws. Ensure that the exposed section of wire is fully inserted and that no loose strands are exposed.

### 3.4 Alarm and output cable connectors

Connect the required cables to the appropriate terminals as shown in figure 1.1. Note the normally open and normally closed relay contact positions, and that the correct polarity and the maximum load specification are strictly observed for the analogue outputs.

Ensure that the wire is fully inserted and that no loose strands are exposed.

### 3.5 Sensor cable

Connect the sensor coaxial cable into the coaxial socket shown in figure 1.1. Route the sensor cable to the intended site of the sensor.

## Installing the air/gas sampling system

The piping installation schematic diagram (see section 4.1) shows all components that could be used in a dry gas measurement application. Not all the items shown will be required for every installation.

Care should be taken to ensure that the sample presented to the measuring sensor is not contaminated with any other component that will damage, contaminate or affect the sensor in a way that will impair the system accuracy.

It is strongly recommended that the sample should not contain particulate matter, oil or other heavy hydrocarbon condensate. If these components contaminate the sample system and/or the measuring sensor, the system response time will be lengthened, although the sensor calibration will not be effected.

**The sample must not contain Ammonia, Chlorine, Ozone or any wet acid vapours or liquid as these will permanently damage the sensor and impair calibration accuracy.**

The flow rate, although not critical to the sensor measurement, should be low enough to avoid abrasion to the sensor surface without being so low as to extend the system response time to an unacceptable level. In general, a flow rate of between 2 and 3 litres/min at NTP will give the right balance.

The sensor is a variable capacitor, which is directly affected by changes in partial pressure of water vapour, and these changes that are proportional to the dew/frost point temperature are displayed on the instrument indicator.

The measuring sensor can be installed directly into the process line, but this does create problems with access for maintenance and calibration. It is for these reasons that we recommend that the sensor be installed in a bypass, fast loop or total loss sample system where the sensor is accessible without interrupting the main process flow line.

## 4.1 Piping installation schematic

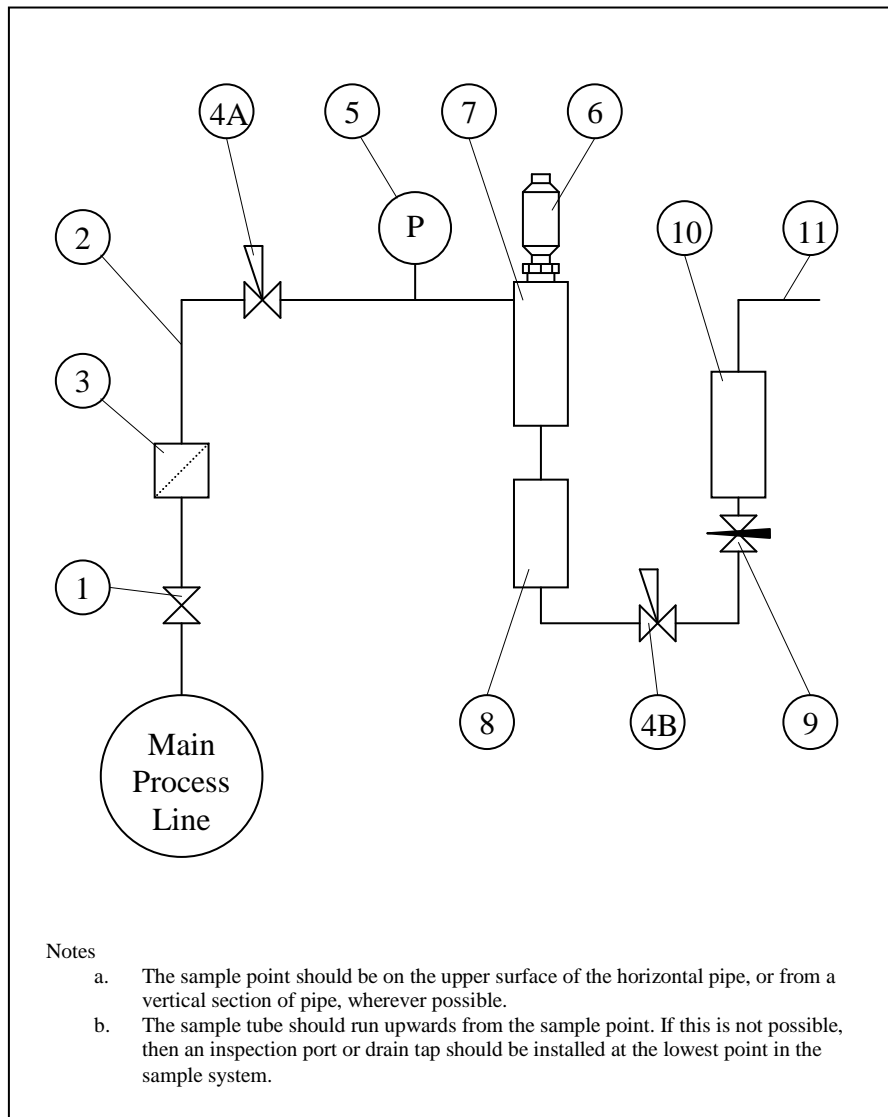

## 4.2 Piping schematic component index

- 1) Sample Isolation Valve – This is a recommended item as it allows access to the sample system without interrupting the main process line.
- 2) Sample Tube – This should be stainless steel for dry air or gas applications but copper or carbon steel can be used where wetter gases are to be measured. If any section of the sample tube must be flexible then PTFE should be used. In most cases, 3mm OD (1/8") is sufficient as it provides good system response time within minimum flow. 6mm OD (1/4") tube can be used where pressure drops across the 3mm tube are too high.
- 3) Filter Unit – A filter unit is recommended when the samples are likely to contain particulate matter. If the air/gas sample contains heavy hydrocarbon condensate, the filter must be of the coalescing type with a drain. The filter unit should be positioned as close to the sample point as practical.
- 4) Pressure Reduction Valve or Pressure Regulator – If the sample is to be measured at atmospheric pressure then the valve 4A should be fitted and 4B omitted from the system. If the sample is to be measured at full line pressure and the exhaust vented to atmosphere, the valve 4B should be fitted and 4A

omitted from the system. If measurements are to be taken at full line pressure and the sample is to be returned to a part of the main line or vent, which is at a pressure higher than atmospheric, and the input to that line needs a controlled pressure, then both 4A and 4B will be required.

- 5) Sample Pressure Gauge – This is not a critical part of the moisture measurement but may be required if Dew/Frost point measurements are to be made at higher than atmospheric pressure.
- 6) Measuring Sensor.
- 7) Sensor Holder.
- 8) Desiccant Chamber – This item is required when the sampling is to be intermittent. When installed, it prevents the ingress of wet air to the sample system while the sample is not flowing, improving the response time.
- 9) Flow Control Valve – This can be a separate item or combined with the flow indicator.
- 10) Flow Indicator – The recommended sample flow is 2 to 3 SL/M.
- 11) Sample Exhaust – The exhaust can be vented to atmosphere or returned to the process line as discussed above.

## 5

### Installing and commissioning the sensor

It is advisable to carry out an initial purge routine of the sample loop before installing the sensor. This is to remove the possibility of sensor damage on start-up.

Refer to the sample system schematic in section 4.1. Open the inlet isolation valve slowly until a small flow of air/gas (at atmospheric pressure) flows through the inlet pipe work to the sensor holder, exhausting through the sensor entry port of the sensor holder.

Allow this purge to continue for about 15 to 20 minutes to remove any residual moisture from the sample pipe work and components.

Close the inlet isolation valve and install the sensor into the sensor holder. Locate and connect coaxial cable in position on the sensor.

Open the inlet valve slowly, by opening all valves after the sensor holder, allow a low-pressure purge through the whole sample system. (Note: If a closed by-pass loop is installed, this section of the procedure is not possible).

Set the required flows within the sample loop.

This completes the installation and commissioning, but on initial start-up, it could take several hours for the system to reach equilibrium. The Superdew 3 will now indicate the dewpoint of the air/gas surrounding the sensor, and the analogue output would be giving mA signals proportional to the indicated dewpoint.

## Default instrument configuration

The standard factory settings are as follows:



- The instrument will display the moisture content in °C Dewpoint
- Both alarms are set to trigger when rising above the upper limit
- The output Span is set to 4-20mA
- The 4-20mA output is set to the full span of the selected range e.g. 4mA = -80°C  
20mA = 20°C
- All security codes are defaulted to 0000







## Programming the Superdew 3

### 7.1 Principle of entering numerical data

See Appendix A, B & C for flow charts

The  key allows the user to leave a part of the menu without changing any settings.

Wherever a numerical value has to be entered into the **Superdew 3** the following text will be found. "Use the ,  &  keys to enter .....". The basic principle used to enter numerical values (integer or floating point) is described here.

The first character of the LCD display flashes to indicate it is active. Use the  key to select the required number between 0 and 9 (plus the minus sign) then press the  key to make the second character flash. Again, use the  key to select the required number between 0 and 9, press the  key to make the third character flash etc.. Continue this process until all characters are entered. In the case of a floating-point numbers in lb/mmsqf or ppm, pressing the  key again makes the decimal point (dp) active. Use the  key to position the dp in the required position. Pressing the  key at any point confirms the numerical value. °C & °F are fixed to 1 dp.

**Note** – The Password used within the **Superdew 3** is made of four integers and does not use the dp.

**Note** – To leave the numerical part of this routine without saving, simply press the  key.

## Configuring the Superdew 3

See Appendix A

To enter the Setup Menu press and hold the  key for 5 seconds. This will display the 'SETUP' message on the LED as in the **Superdew 3** Setup Menu Flow Diagram (see Appendix A).





Pressing the  key again enters the setup menu map at the 'rAngE' option on the top level. There are 7 top level options described below:

**Note:** The default set-up will go directly from the SETUP message to the rAngE screen. However, if the user has set a password, then the user is prompted to enter the correct password before continuing on to the top level.

**Note:** Most of the screens within the menu have an active 10-second timeout. Therefore, if no keys are pressed within this period the unit reverts automatically to normal operation. In most cases where the 10-second timeout occurs, changes will not have been saved.

## 8.1 rAngE

**Description** – The '**rAngE**' option allows the user to select the required sensor range. This option is used to match the Superdew 3 to the sensor connected to the unit. For example a '**RED**' sensor requires that the Superdew 3 '**rAngE**' option '**rEd**' is selected.



**Operation** – While '**rAngE**' is displayed press the  key to enter the subroutine. The display now shows the currently selected sensor range. Use the  key to scroll through the options until the required range is displayed. Press the  key to select the new range. The message 'Conf' will be displayed. Press the  key again to confirm selection.

**Note:** Pressing the  key at any time reverts to the '**rAngE**' screen without saving any change.



Note: See Superdew 3 Specification for detailed information on ranges.



## 8.2 oUtPt

**Description** – The '**oUtPt**' option of the Superdew 3 allows the user to set the span and the range over which the 4-20mA operates. The default setting is for the output to cover the full operating span of the selected range e.g. 4mA to equal -100°C and 20mA to equal 0°C. It is possible to set a more focused span, such as 4mA to equal -60°C and 20mA to equal -20°C. It is also possible to select 0-20mA as well as 4-20mA.

**Operation** – While '**oUtPt**' is displayed press the  key to enter the subroutine. The display now displays '**SPAn**' use the  key to select either '**Hi**', '**Lo**' or '**SPAn**' then press the  key.

**Note** - If the  key is pressed the **Superdew 3** will return to the '**oUtPt**' screen.



If the '**SPAn**' option is selected, use the  key to select the required span (0-20mA or 4-20mA). Press the  key to confirm selection.

If either the '**Lo**' or '**Hi**' options are selected the screen will now display the current High or Low range value. Use the  &  keys to enter the new value. Press the  key to confirm and **save** the new value. The other range limit can now be set by following the same process.

**Note** – Once the  key is pressed to set either the high or low range limit, that value is written to memory and will not revert to the previous value even if the 10-second timeout occurs.

## 8.3 AL1 & AL2

**Description** – The AL1 & AL2 option allows the user to setup two independent alarms. Trip point, direction of trigger' relay enable status, latching status and hysteresis can be set within this option.

**Operation** – While '**AL1** or **AL2**' are displayed press the  key to enter the subroutine. The LED now displays '**SEtPt**'. Use the  key to select the required function and then press the  key.

**Note:** - If the  key is pressed the **Superdew3** will return to the '**AL1 or AL2**' screen.



Depending on the option selected, the user will now be able to perform the following functions: -

'SEtPt'	Enter the alarm set point.
'tYPE'	Select if the alarm is to activate on a rising signal 'Hi', falling signal 'Lo' or 'OFF'.
'rELAY'	Select if the relays are Energised 'En' or de-energised 'dE-En'
'LAtCh'	Set if the alarm is Latch 'YES' or not latching 'nO'.
'HYSt'	Enter the hysteresis value.



**Note** – Once the  key is pressed to set any of the alarm parameter, that value is written to memory and will not revert to the previous value even if the 10 second timeout occurs.

## 8.4 rS485 (communications)

**Description** – The rS485 option allows the user to set the **Superdew3** address and communication baud rate used when the **Superdew3** is communicating with a PC using RS485 point-to-point communications.



**Operation** – While 'rS485' is displayed press the  key to enter the subroutine. The display now displays 'Addr' use the  key to select either 'Addr', or 'bAUd' then press the  key.

**Note** - If the  key is pressed the **Superdew 3** will return to the 'rS485' screen.

If the 'Addr' option is selected the screen will now display the current address value. Use the  &  keys to enter the new value. Press the  key to confirm and **save** the new address.





**Note** – Once the  key is pressed to set the address, that value is written to memory and will not revert to the previous value even if the 10 second timeout occurs.

**Note** – Legal addresses are 1 to 32.

If the 'bAUd' option is selected, use the  key to select the required baud rate (9600, 4800, 2400 or 1200). Press the  key to confirm selection.



## 8.5 PASS

**Description** – The PASS option allows the user to alter the security password used to protect the 'SetUP' menu.

**Operation** – While 'PASS' is displayed press the  key to enter the subroutine. The LCD now displays '0000'. Use the ,  &  keys to enter the new password.

## 8.6 PAnEL

**Description** – The PAnEL option allows the user to restrict the functions of the front panel Hotkeys. If the 'On' option is selected, the Hotkeys are unrestricted.

**Operation** – While 'PAnEL' is displayed, press the  key to enter the subroutine. The LCD now displays 'On' or 'OFF'. Use the  key to select 'On' or 'OFF'. Press the  key to confirm selection.

## Normal operation of the Superdew 3

In normal operation, the **Superdew 3** will display the current moisture value of the connected sensor. The value is displayed in the currently selected engineering units, which is indicated by the small LED.

The Alarm LED's (AL1 & AL2) will light whenever an alarm condition occurs and only turn off when the alarm condition clears.

Remote signalling of an alarm condition is provided by two internal changeover relays that trigger at the same time as the LED's.



## Hotkeys





### 10.1 Alarm Keys

See Appendix B

**Description** – The 'AL1 & AL2' Hotkeys allow the user to review and alter the Alarm trigger points without interrupting the monitoring process.

If the Hotkeys are restricted by the '**PAnEL**' function then the alarms can only be reviewed.

**Operation** – To review the alarm trip point press the  (AL1) or  (AL2) key momentarily. The screen will display the set trip point for 2 seconds before reverting to the dewpoint reading.



To alter the trip point press and hold the  (AL1) or  (AL2) keys for longer than 5 seconds. The screen will display and allow the user to alter the trip point using the ,  &  keys

### 10.2 Units

See Appendix C

**Description** – The 'Units' Hotkey allows the user to review and alter the displayed units.

If the Hotkeys are restricted by the '**PAnEL**' function then the units can only be reviewed. If the  key is pressed to select another moisture unit, the **Superdew3** will display '**LOC**' and not change the moisture units.

**Operation** – To review the **Superdew3** moisture units press the  (Units) key for longer than 5 seconds. The screen will display the current moisture reading in the currently selected moisture units. Press the  key to scroll through the current moisture level in each of the moisture units. Press the  key to select a different moisture unit.

## Calibration (Sensor Ranges up to 0°C Dewpoint)

A major advantage of the Superdew3 is the Autocal Feature.

The system relies on the fact that each sensor is designed to give no further increase in reading when it reaches its maximum moisture level. This means that, for instance, the Silver Spot or Red Spot sensor will read –20°C Dewpoint when it is exposed to gas at –20°C Dewpoint, but will continue to read -20°C Dewpoint when it is exposed to wetter gas. The system can therefore be calibrated very simply by exposing the sensor to anything wetter than –20°C Dewpoint and adjusting the reading to that point on the display. For the Grey Spot Sensor the maximum level is 0°C DP and the same principle applies.

In practice, an autocal is performed as follows:-

1. Ensure the Superdew3 is powered up.
2. Remove the sensor from the sensor holder and expose it to ambient conditions for at least 1 minute.
3. Check the Superdew3 reading. It should display the maximum level of Dewpoint for the instrument (i.e. –20°C for Red and 0°C for Grey).
4. If the unit is reading incorrect then use a small screwdriver to turn the Autocal potentiometer (found on the front panel of the instrument under the knurled cap) clockwise to increase the reading (wetter) or anticlockwise to decrease it.

## Calibration (Sensor Ranges up to +20°C Dewpoint)

In order to calibrate a +20°C Sensors, it is necessary to measure the ambient air Dewpoint by some other method. Careful use of a sling or whirling hygrometer can achieve accurate results or a cooled mirror device can be used.

The following procedure should be used:-

1. Ensure the Superdew3 is powered up.
2. Remove the sensor from the sensor holder and expose it to ambient conditions for at least 1 minute.
3. Compare the reading of the Superdew3 in the ambient air, against the actual moisture level obtained by another method. Turn the Autocal potentiometer (found on the front panel of the instrument under the knurled cap) using a small screwdriver clockwise to increase the reading (wetter) or anticlockwise to decrease it.

## Monitoring the system

The system is designed to operate continuously with a minimum amount of operator input.

It is, however, advisable to inspect the sample loop periodically to ensure that the required flows are being maintained.

The number and type of items employed in the sample loop will determine what, if any, other routine checks should be made. If, for instance, a filter is used, the filter element should be inspected periodically and changed when necessary.

The instrument should not require any routine maintenance, but if any malfunction is suspected, it is advisable to contact your local dealer.

Should it be necessary at any time or for whatever reason, to change either the instrument or sensor, it should be noted that the components of the **Superdew 3 sensor** system are completely interchangeable.

14

## Faults / Errors

If the sensor is short-circuited the display will read '**Short**', the voltage output will drive to full scale, the current output will drive to 24mA and both alarms/relays will trip.

If the user tries to enter an alarm level above the maximum value of the sensor range selected, the Superdew 3 will display '**oVER**'.

15

## Superdew 3 Specification

Transmitter:	Compatible with the Shaw Sensor			
Enclosure:	DIN Style, 144mm wide, 72mm high by 116mm deep.			
PCB Layout:	General PSU PCB and Display PCB to fit the DIN enclosure.			
Display:	Five characters LED display. Largest positive number 99999.			
Alarm & Range Limits:	Upper Limit	Lower Limit	} Limited to Sensor Range	
	°C Dewpoint	20.0		-100.0
	°F Dewpoint	68.0		-184.0
	P(PPM)	9999		0.001
	L(lb/MMSCF)	1000		0.001
Front Panel:	A membrane keyboard with four keys and four windows for the four character LCD, the single character seven segment LED and the two alarm LED's.			
Power Supplies:	Universal 90 – 250VAC 50/60hz or 24VDC versions.			
Alarms:	Two single pole changeover contacts (NO/C/NC), rated at 10A at 240VAC. Alarm trip at set point with 0.1°C (or equivalent) hysteresis to eliminate relay chatter.			
Analogue Outputs:	Isolated 4-20mA as standard. The span of the outputs can be set by software control.			
Temperature Range:	Electronics	-10°C to +60°C	Sensor	-10°C to +50°C
EMC:	Designed to meet the EMC and LVD directives.			



# Appendix A – Superdew 3 Setup Menu Flow Diagram

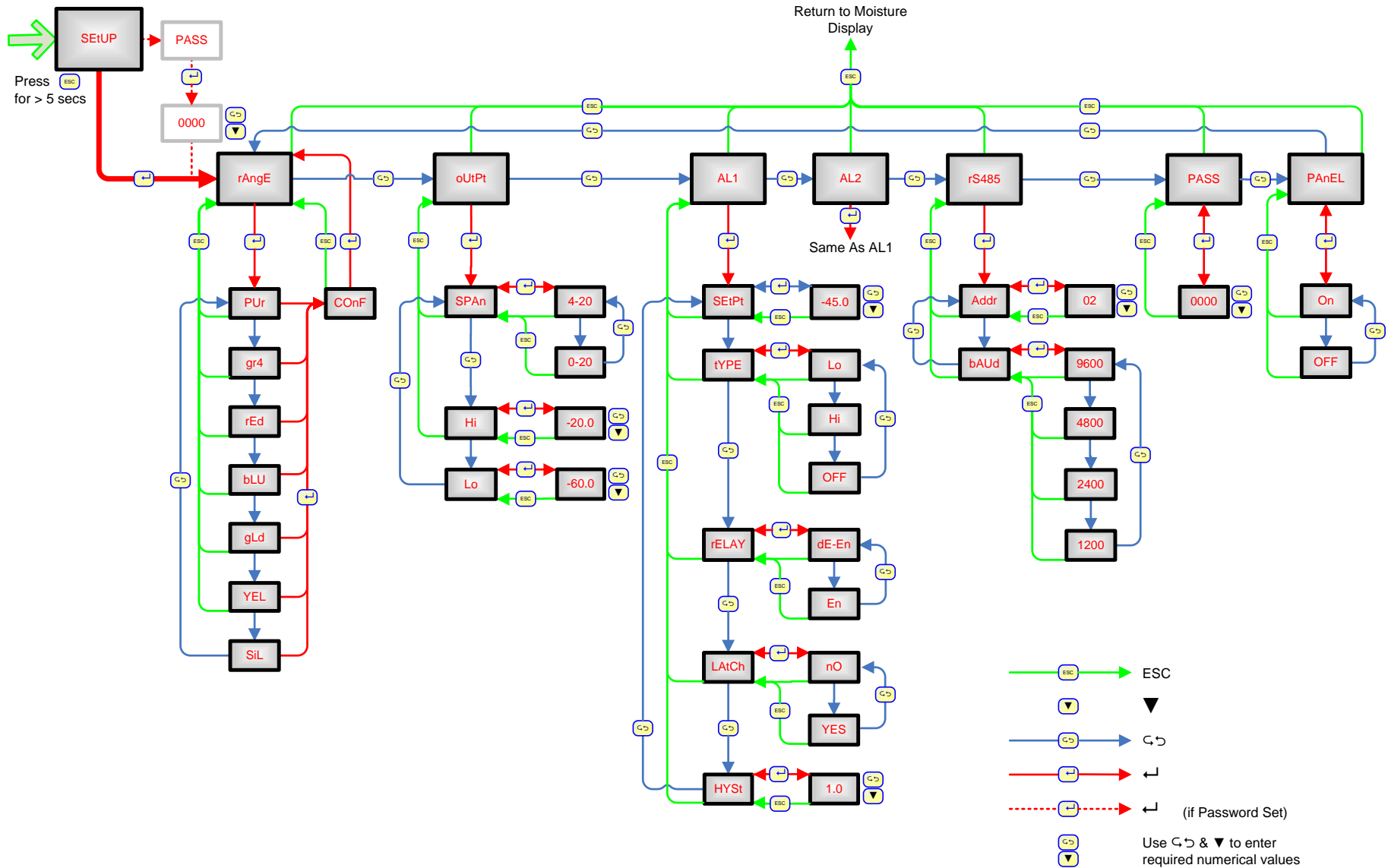

## Appendix B – Alarm 1 & 2 Hotkey Flow Diagram

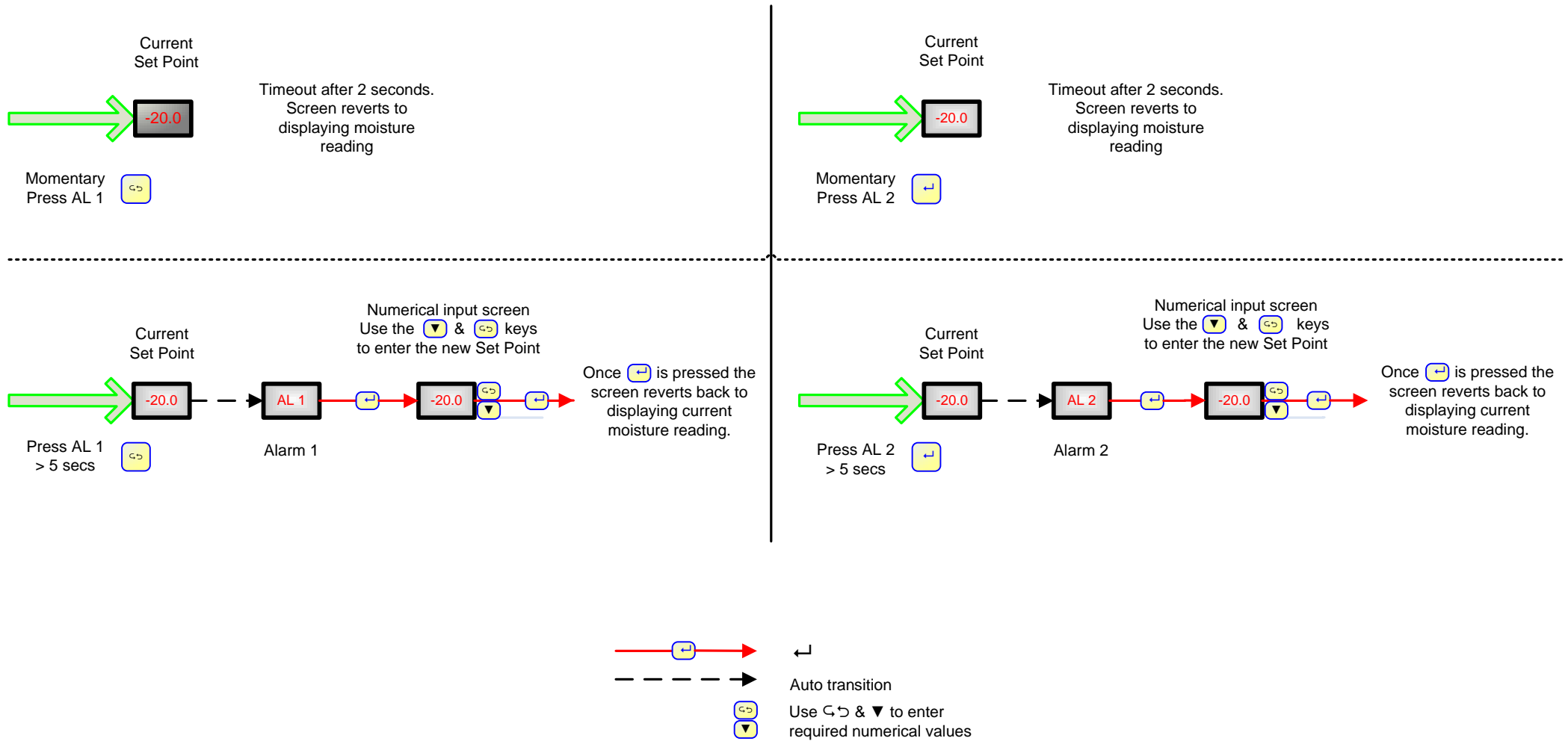

# Appendix C – Units Hotkey Flow Diagram

